

**BULLET PROOF FB4 FB5 FB6 FB7 BALLISTIC LEVEL AUTOMATIC MOTORIZED
SLIDING GATES**

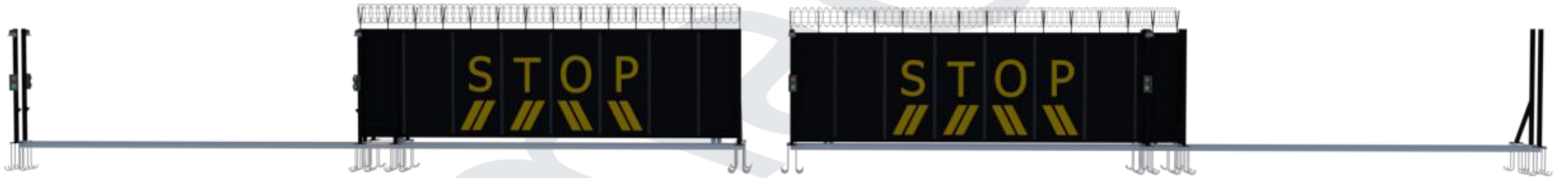

MADOORS
BPSG-500 SERIES



MADOORS SİSTEM LTD.ŞTİ
Address;

MADOORS SİSTEM SARAY MAHALLESİ ATOM CADDESİ KÜME EVLERİ
NO : 155 KAHRAMANKAZAN ANKARA UZAY VE HAVACILIK SANAYİ
TAI KARŞISI HAP

Bullet Proof Automatic Gates

VIEWS ;

MADOORS
BPSG-500 SERIES

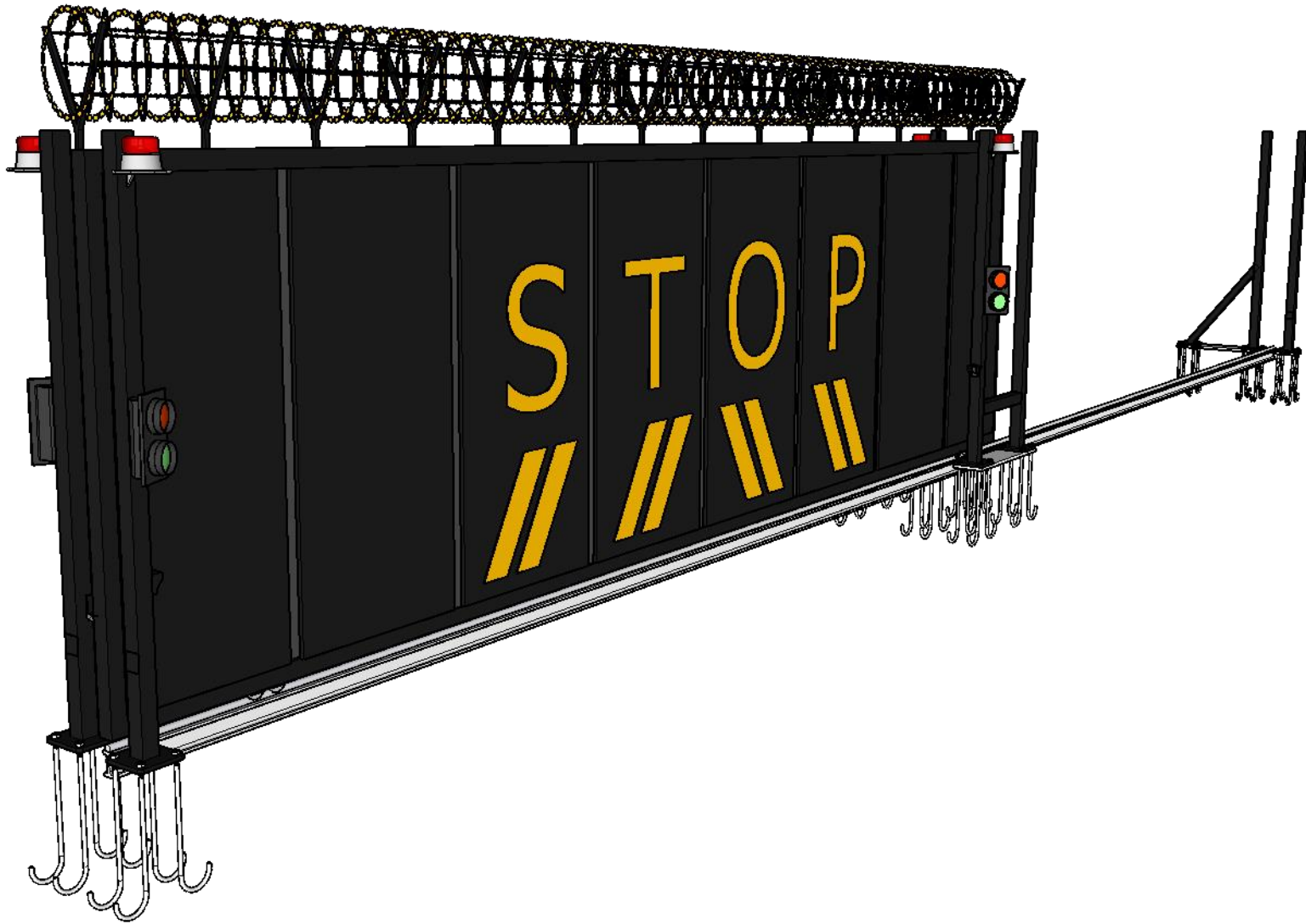

MADOORS

VIEWS ;

MADOORS
BPSG-500 SERIES

Gates Is Close

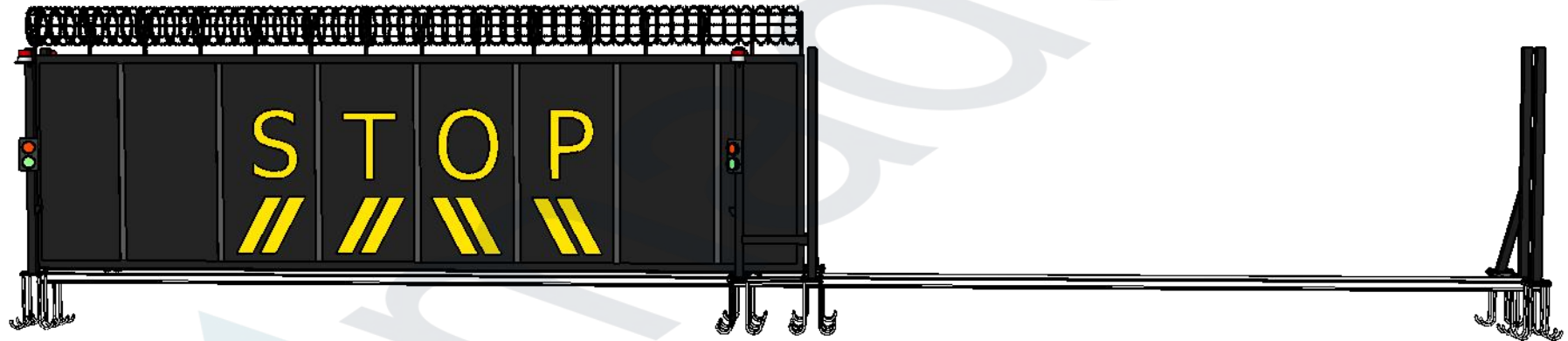

MADOORS

VIEWS ;

MADOORS
BPSG-500 SERIES

Gates Is Open

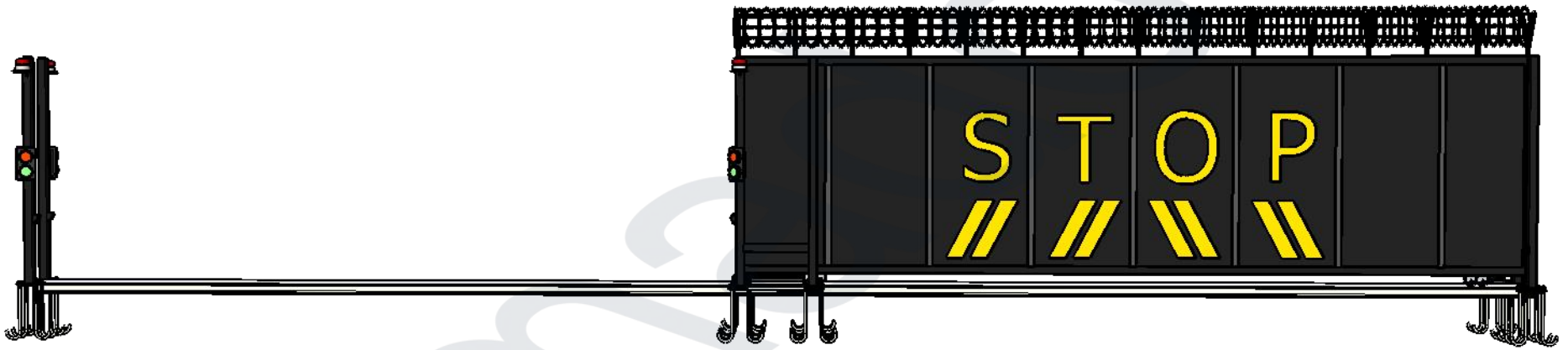

PARTS;

**MADOORS
BPSG-500 SERIES**

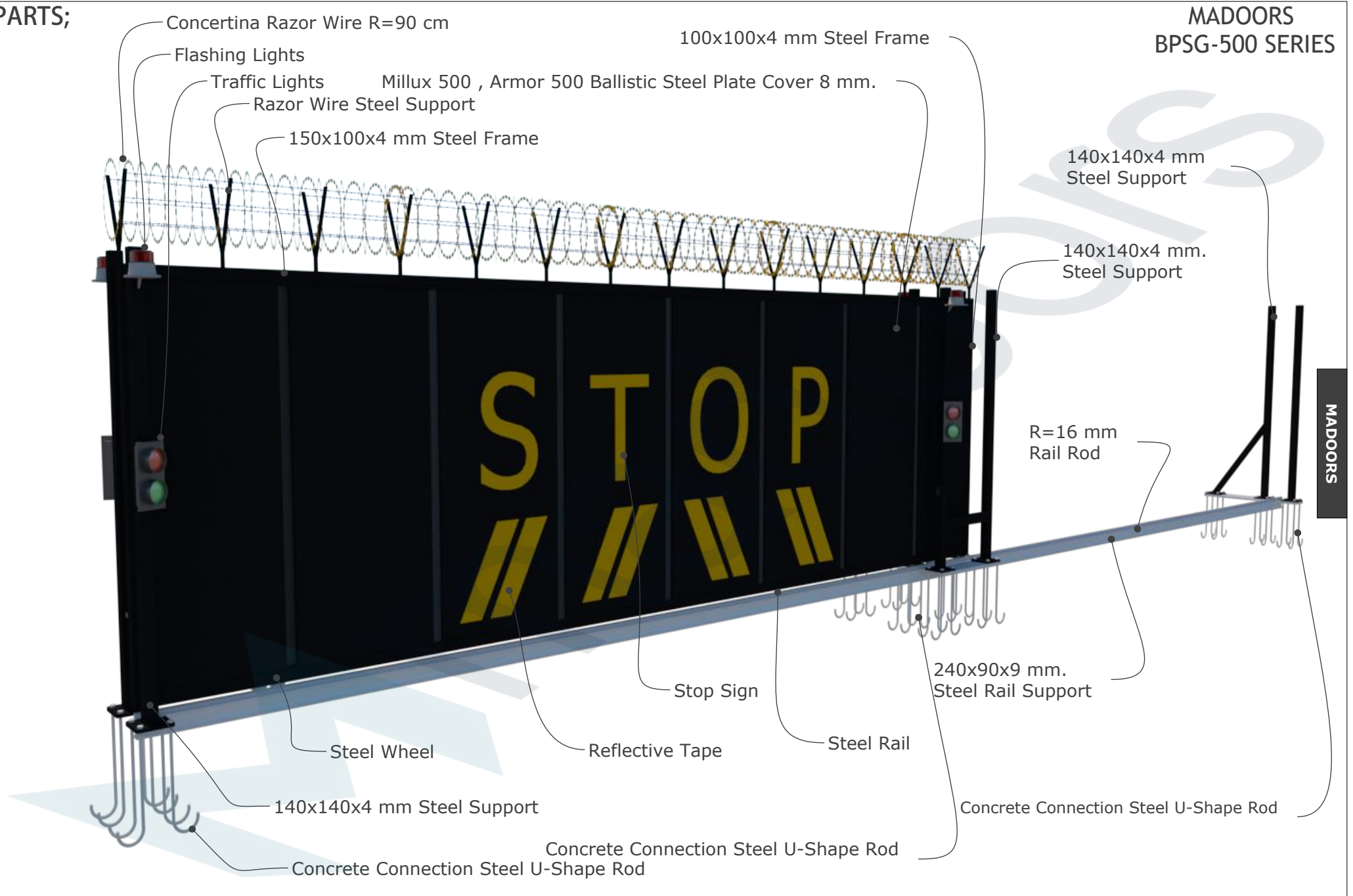

MADOORS

PARTS;

MADOORS
BPSG-500 SERIES

Door is Closed
Front View

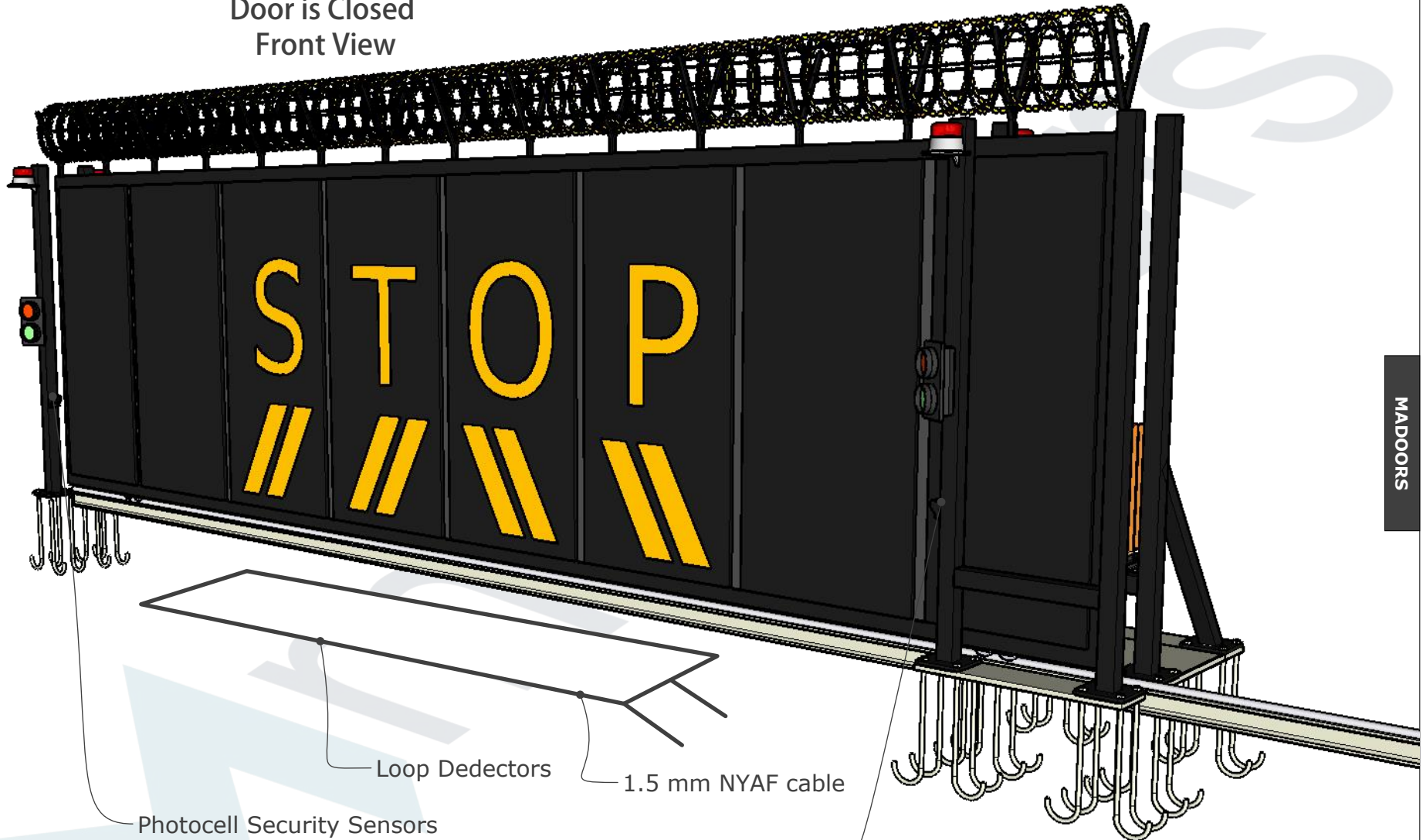

Photocell Security Sensors

Loop Detectors

1.5 mm NYAF cable

Photocell Security Sensors

MADOORS

PARTS;

MADOORS
BPSG-500 SERIES

Door is Closed
Back View

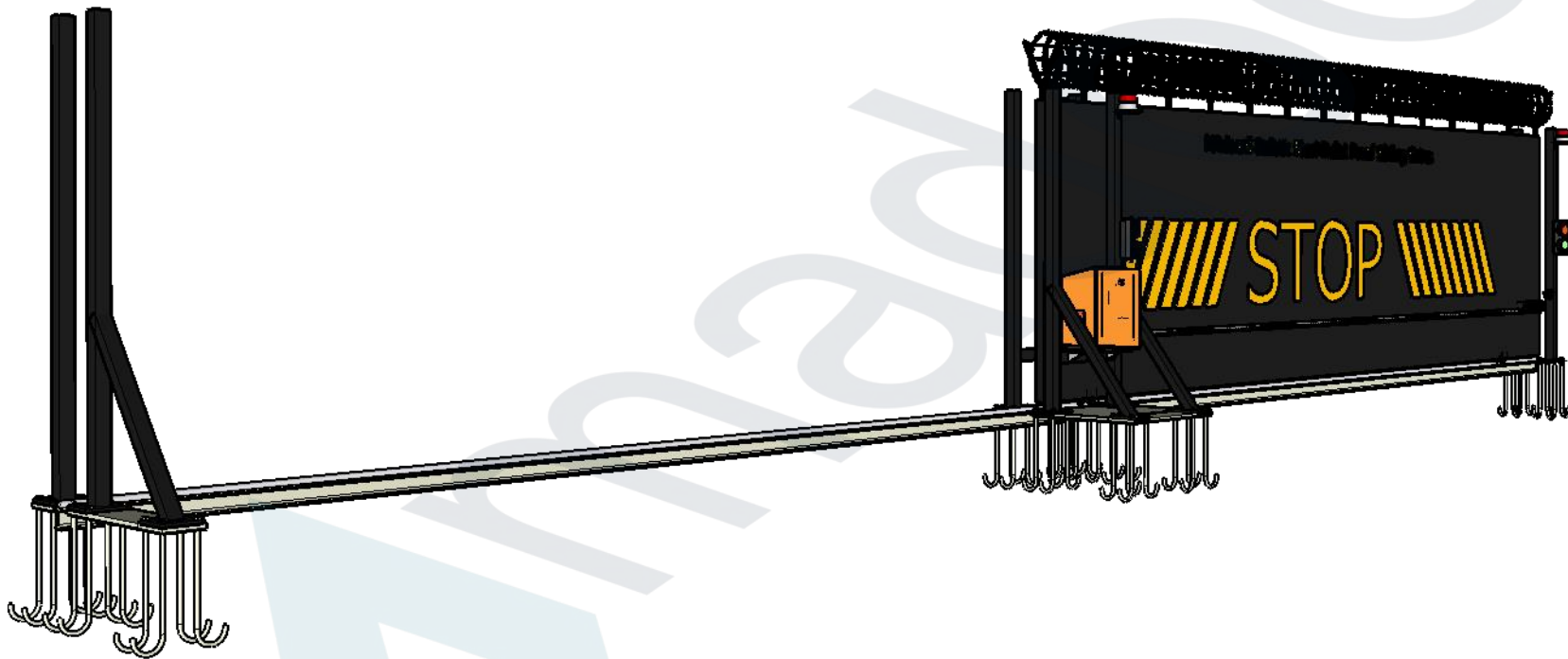

MADOORS

PARTS;

MADOORS
BPSG-500 SERIES

Door is Closed
Back View

MAdoorS Ballistic Steel Bullet Proof Sliding Gates

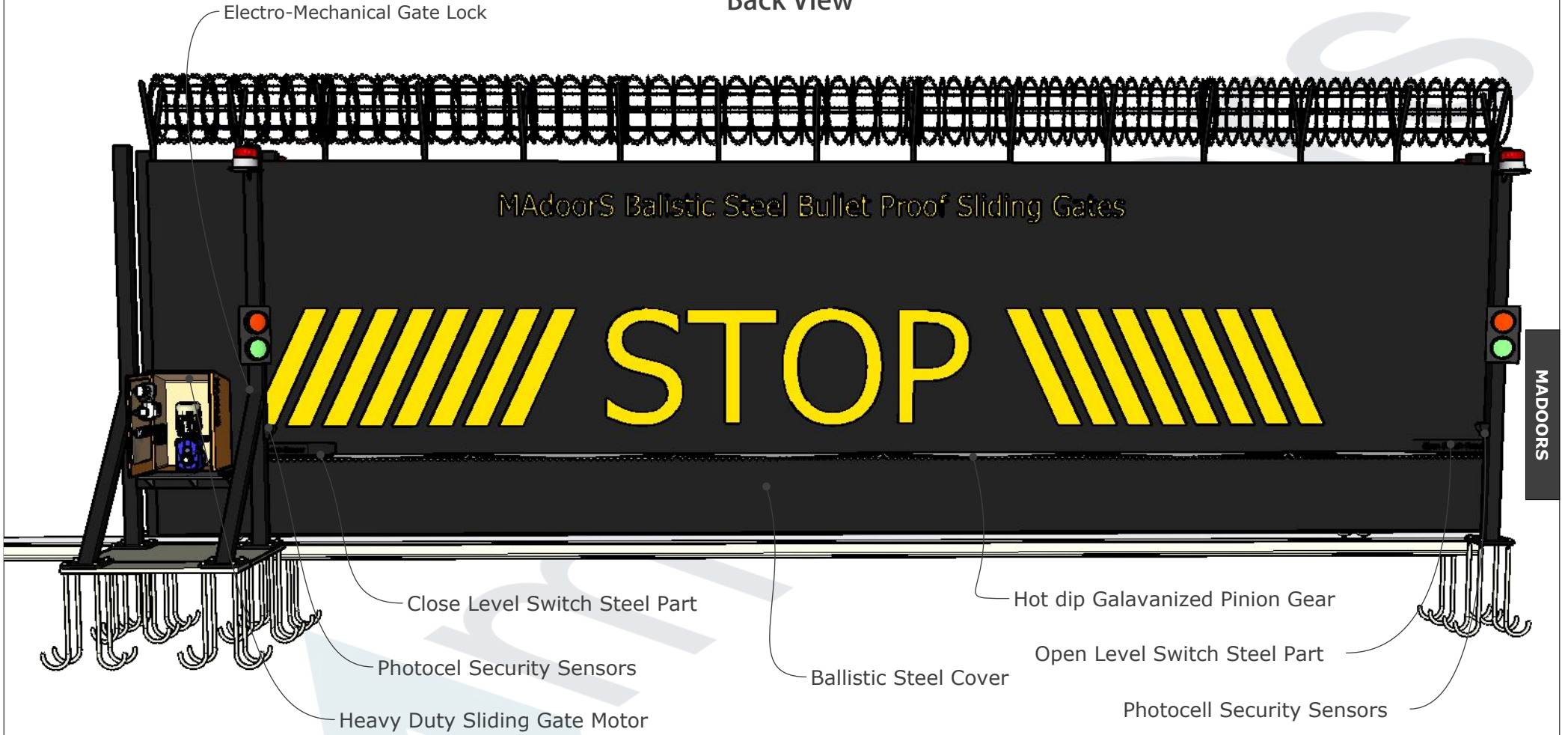

PARTS;

MADOORS
BPSG-500 SERIES

Door is Closed
Back View

- Manual Using Handle
- Siemens 1.1 kW Electrical Motor
- Reducer
- Ventilation Fan
- IP67 Steel Cabinet
- 24 volt DC. Power Supply
- 1x10 amp.Fuse
- 3x20 amp. Fuse
- Phase Safety Control Relay
- Motor Safety Termic Relay
- Siemens Speed Controller
- Motor Connection Terminal
- Open-Close Limit Switches
- Remote Controller Receiver Card
- PLC Control Unit And Software

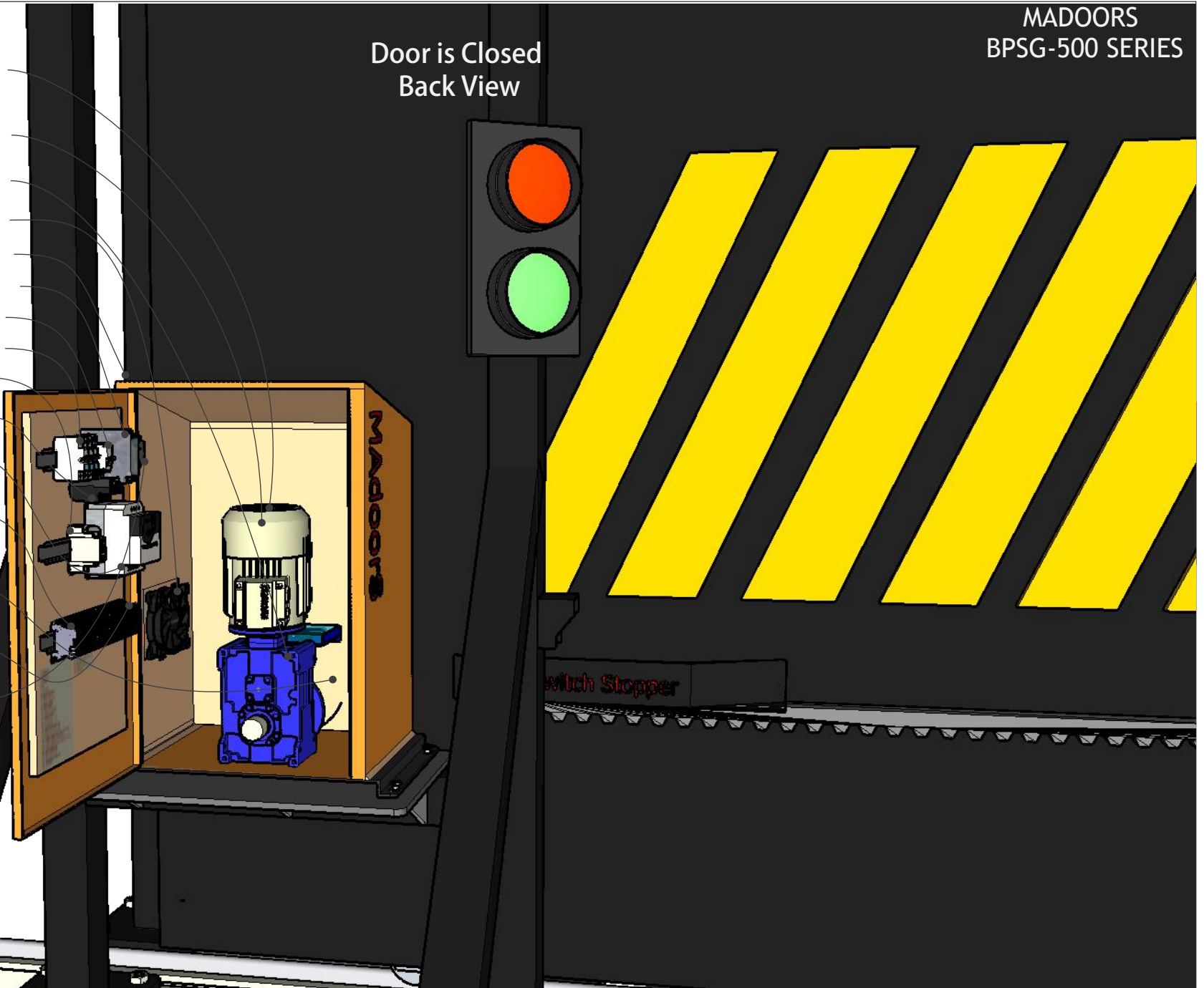

DIMENSIONS;

**MADOORS
BPSG-500 SERIES**

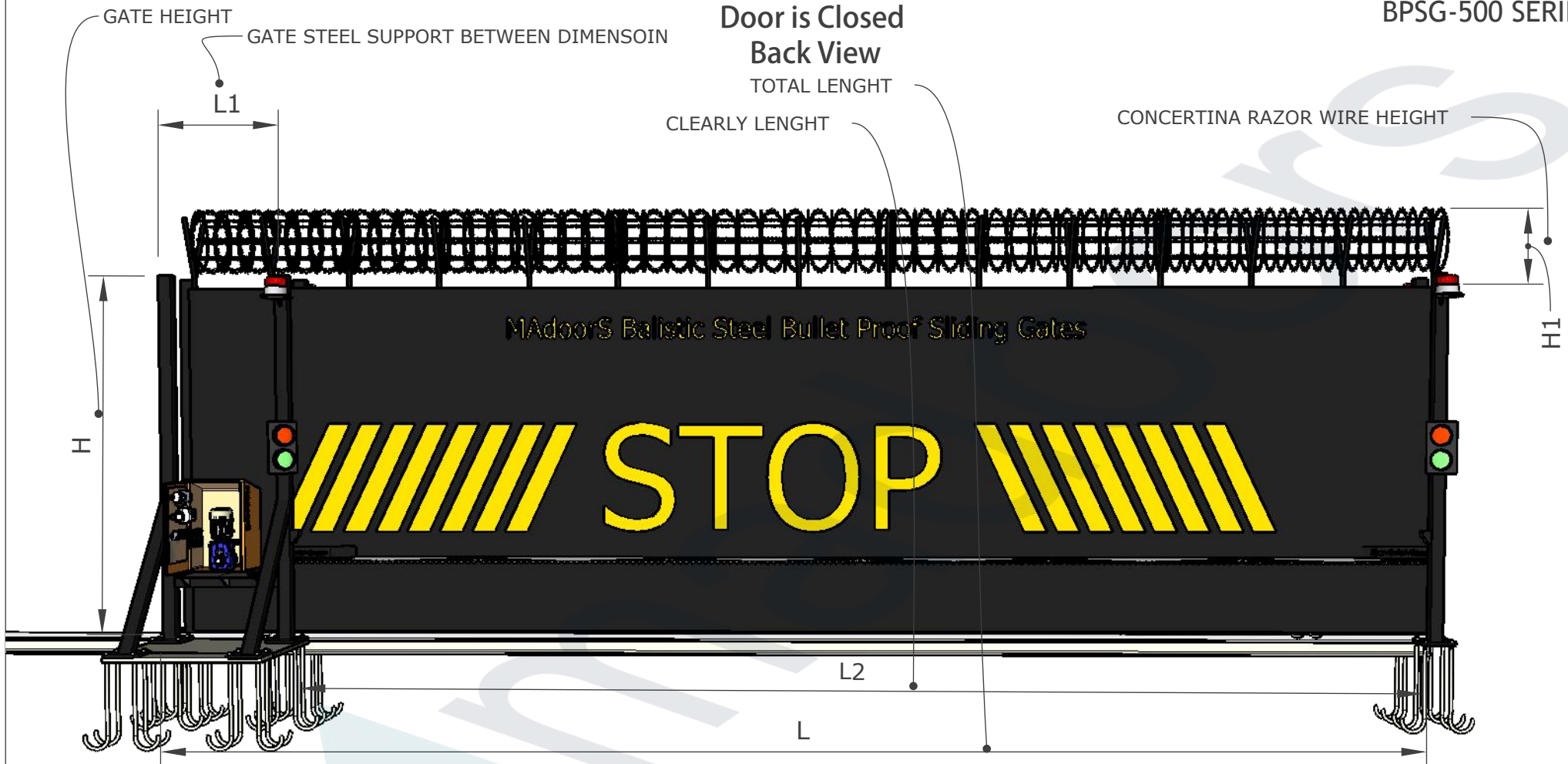

MADOORS

	L (Meters)	L1 (Cm)	L2 (Meters)	H (Cm)	H1 (Cm)
BPSG-500	4-5-6-7-8-9-10	80-90-100 cm	3-4-5-6-7-8-9	200-250-360 cm	50-60-90 cm.
BPSG-500	4-5-6-7-8-9-10	80-90-100 cm	3-4-5-6-7-8-9	200-250-360 cm	50-60-90 cm.
BPSG-500	4-5-6-7-8-9-10	80-90-100 cm	3-4-5-6-7-8-9	200-250-360 cm	50-60-90 cm.
BPSG-500	4-5-6-7-8-9-10	80-90-100 cm	3-4-5-6-7-8-9	200-250-360 cm	50-60-90 cm.
BPSG-500	4-5-6-7-8-9-10	80-90-100 cm	3-4-5-6-7-8-9	200-250-360 cm	50-60-90 cm.
BPSG-500	4-5-6-7-8-9-10	80-90-100 cm	3-4-5-6-7-8-9	200-250-360 cm	50-60-90 cm.