

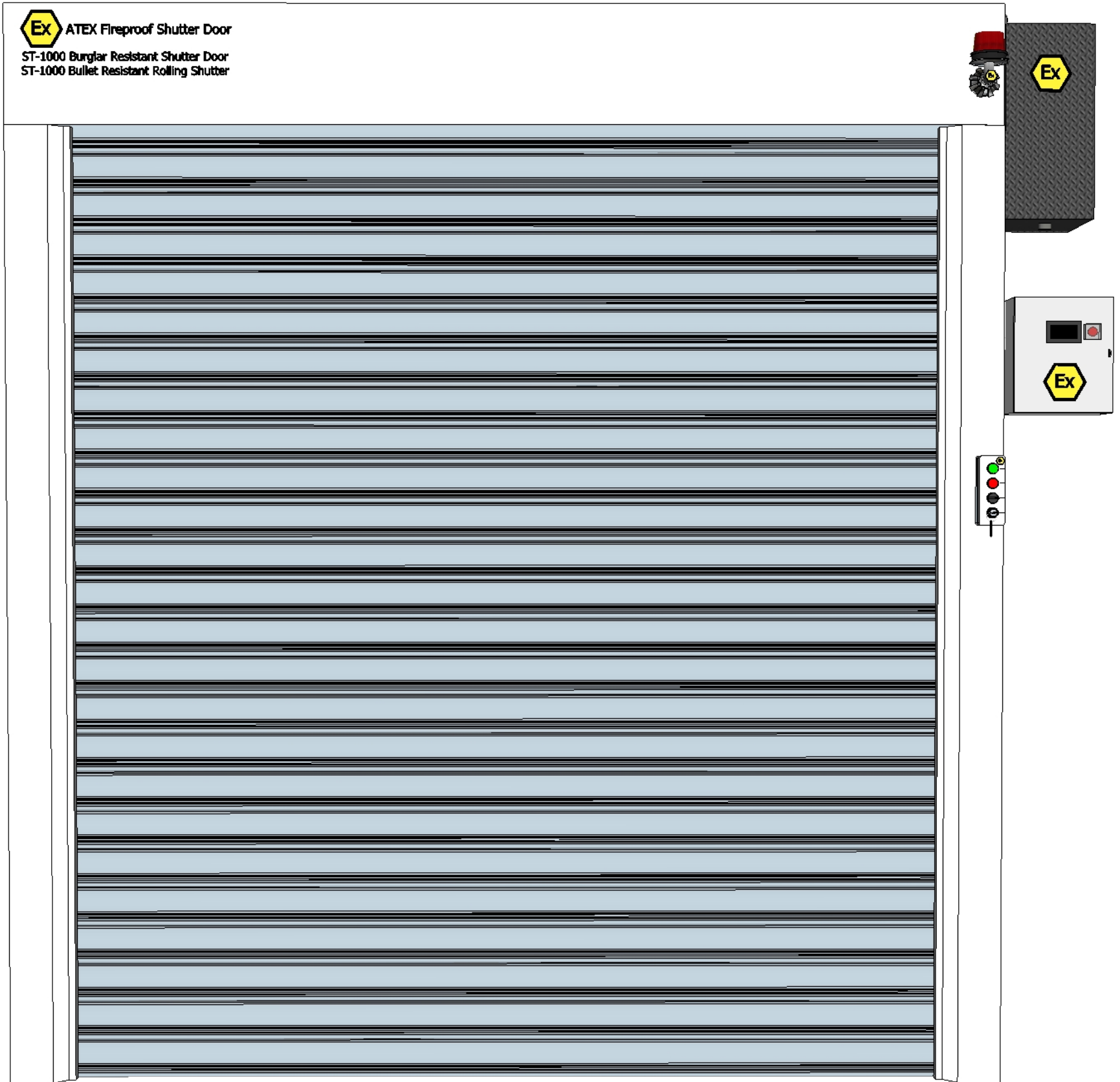

**ST-1000 SERIES  
FIRE PROOF  
EXPLOSION PROOF  
BULLET RESISTANT  
BURGLAR RESISTANT  
AUTOMATIC MOTORIZED ROLLING SHUTTER DOOR**





## Bulletproof Automatic Roller Shutter Door , Bullet Resistant Motorized Shutter Window Systems

Our products are manufactured using ballistic steel . The ballistic steel used is bulletproof, bullet resistant and approved and reported by authorized institutions. Our roller shutter doors, which are manufactured in ballistic steel and aluminum type, that open and close by turning and wrapping the drum, are guaranteed by our company for 2 years. According to ballistic levels, we have the opportunity to manufacture at European standards BR3 - BR4 - BR5 - BR6 - BR7 bulletproof level. As an American standard, we manufacture bulletproof steel - aluminum type shutter and shutter system with ballistic report between these levels, including UL752 level 1 and level 9.

Our motor systems are siemens brand with side drive. The reducers are worm geared Italian type reducers. Our bulletproof steel roller shutter systems are designed and manufactured in the desired dimensions according to the projects of our customers. From the windows of the buildings

# PARTS

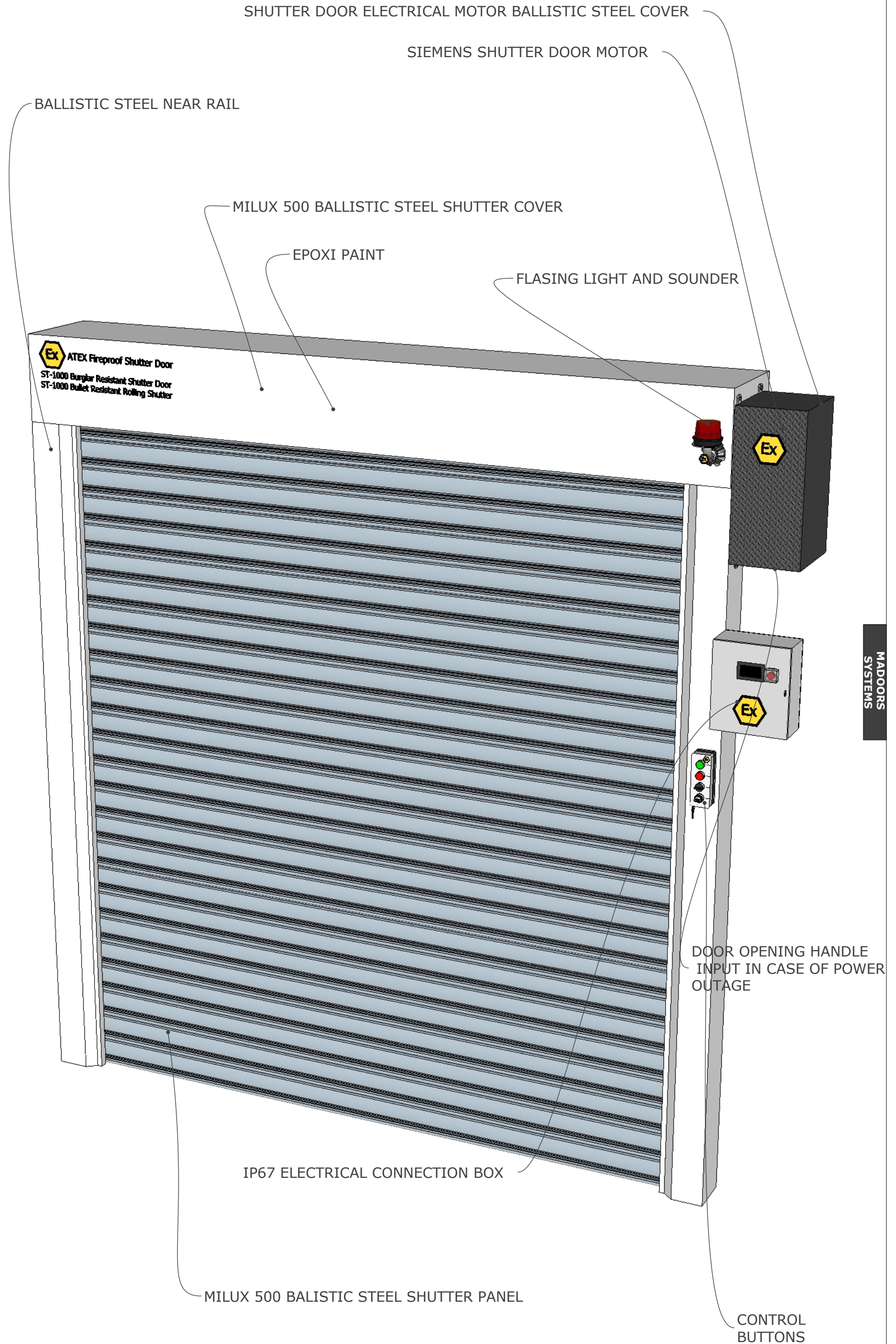

# DIMENSIONS

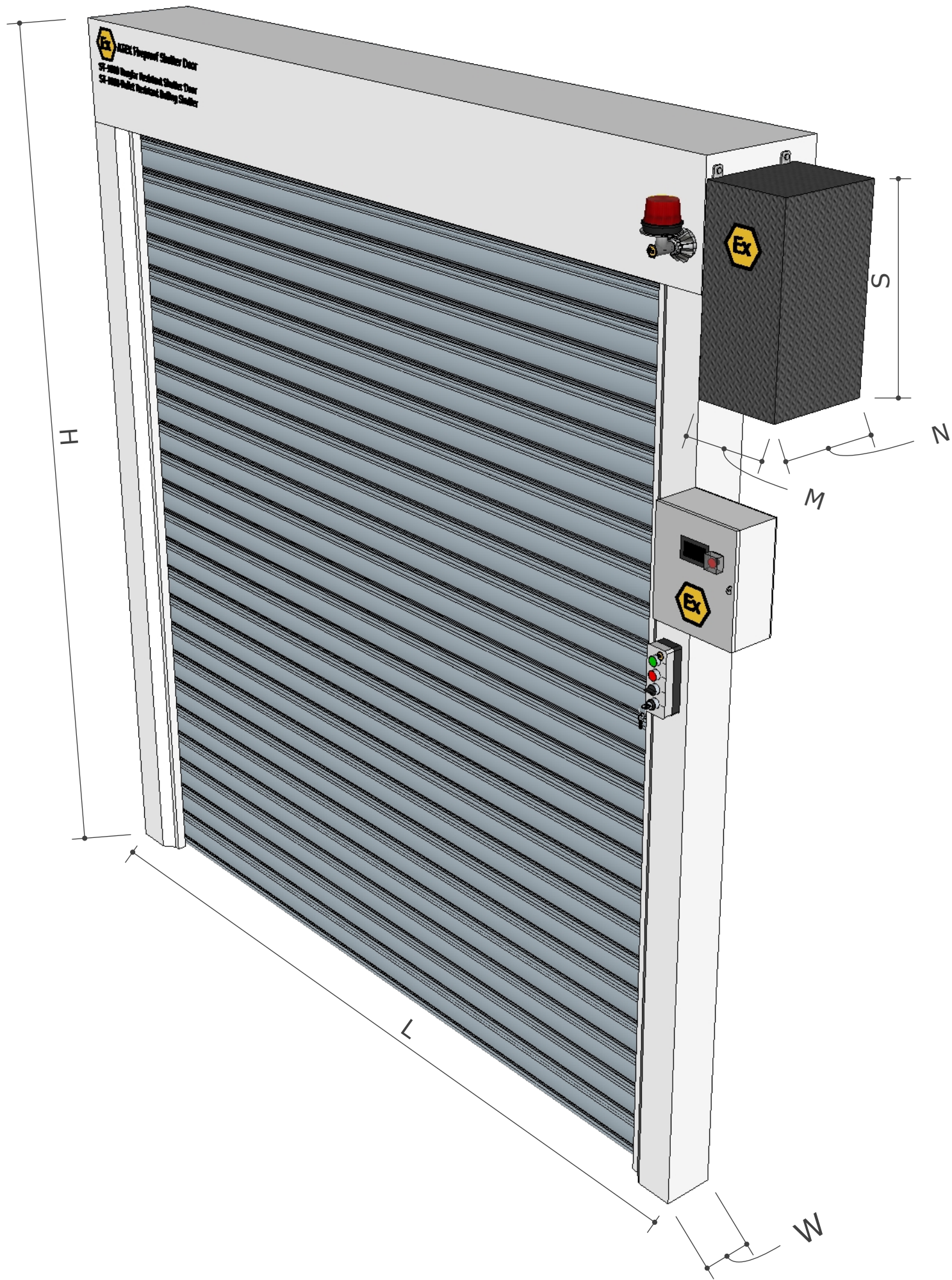

## Shutter Dimensions

H = 1 - 1.5 / 2 - 2.5 / 3 - 3.5 / 4 - 4.5 / 5 - 5.5 / 6 - 6.5 METERS

L = 1 - 1.5 / 2 - 2.5 / 3 - 3.5 / 4 - 4.5 / 5 - 5.5 / 6 - 6.5 METERS

W = 10 / 15 / 20 CM

## Motor Box Dimensions

M / N / S = 30 / 30 / 50

M / N / S = 40 / 40 / 60

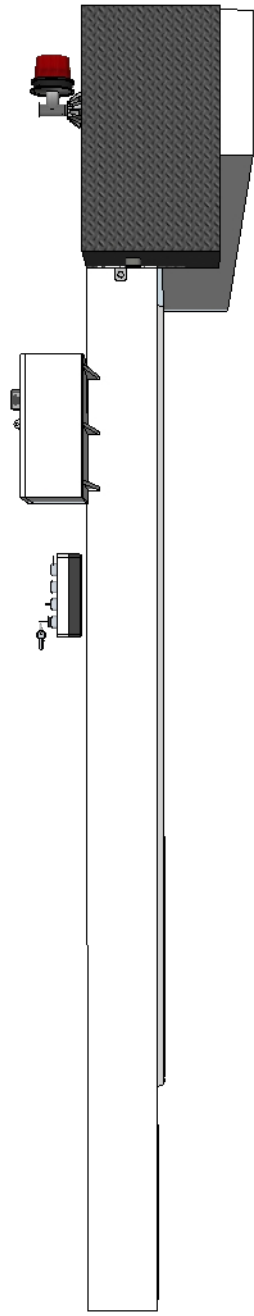

RIGHT SIDE VIEW

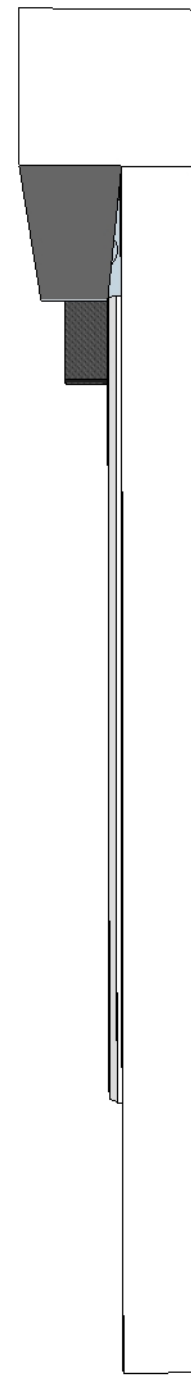

LEFT SIDE VIEW

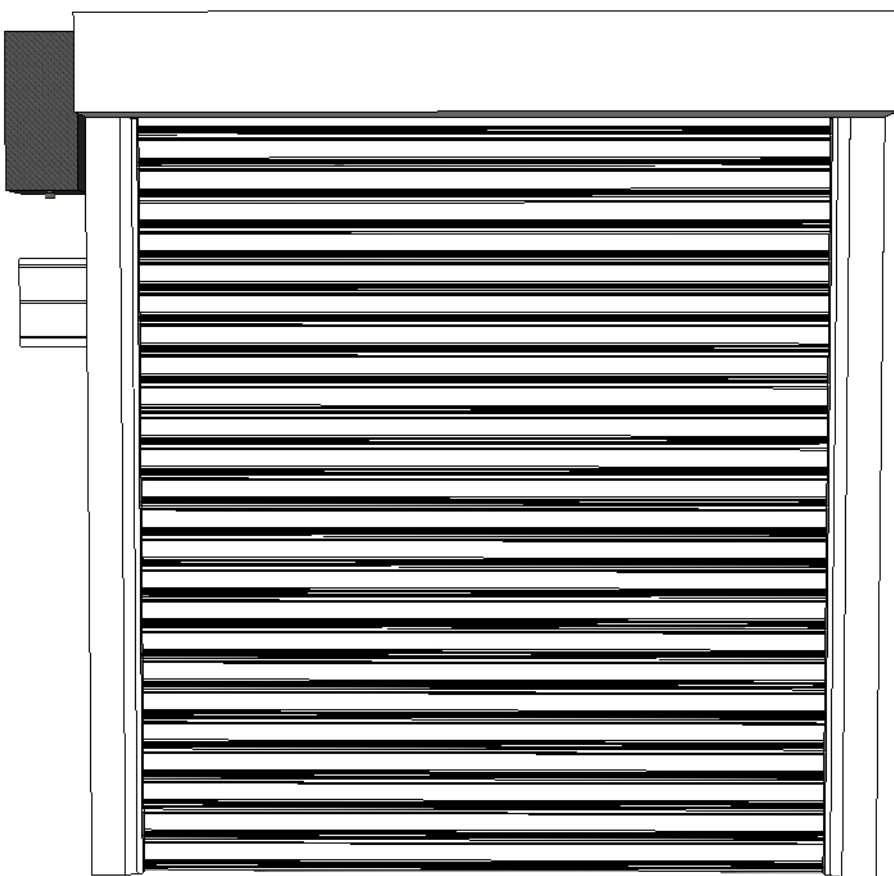

BACK SIDE VIEW

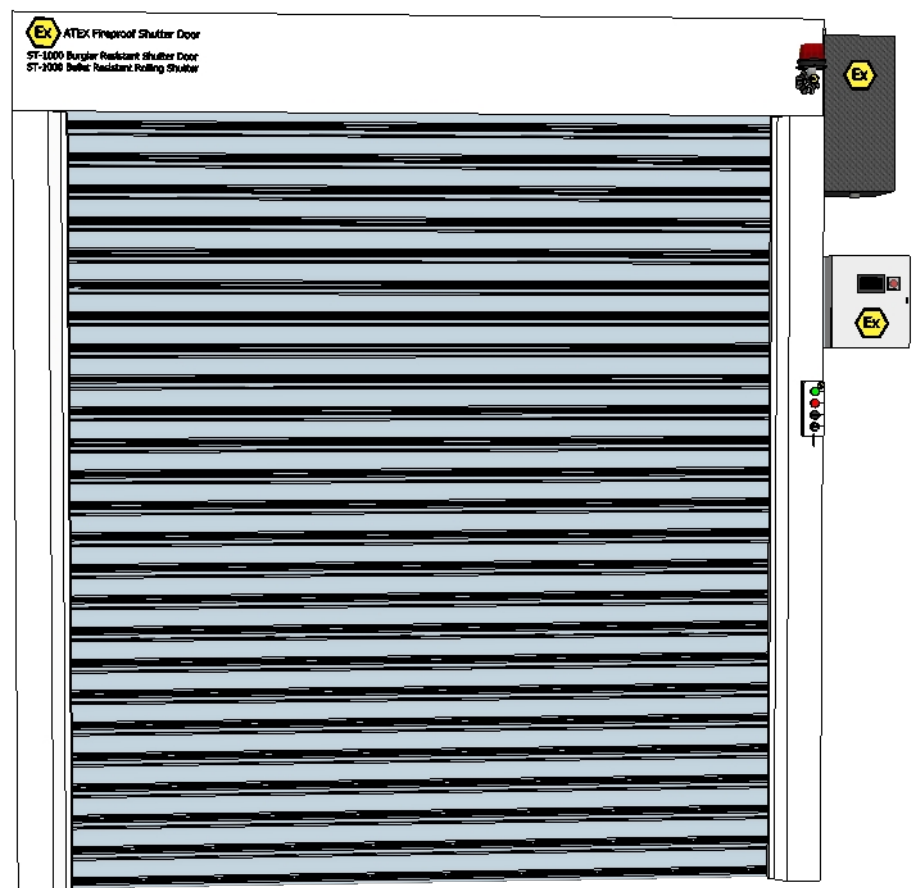

FRONT SIDE VIEW

Our ST-1000 Series Rolling Shutter is an ultra heavy-duty product that is bullet resistant for maximum home protection.

Still boasting our unique slimline design the Ultimate Roller Shutter, window shutter is electrically operated and comes in 3 standard colours. Our ST-1000 Series Rolling Shutter is perfect for any home that deserves the ultimate in protection. They not only offer solutions for noise reduction and cooling but after installation, any room in your home is transformed into a complete safe haven, being protected from all main weapons found on the streets today. It stops in their tracks bullets fired at close proximity from a 9mm handgun, 38 special, 12 gauge shotgun, 22 calibre and a Dirty Harry 460. Alongside being the superior choice when it comes to protecting those near and dear to you our ultimate shutters also are attractive to the eye. As previously mentioned our shutters are uniquely designed to suit all world homes and fit windows seamlessly. You get the protection of tank armour without the bulky look.

## ST-1000 BULLET-PROOF AND BURGLAR-PROOF

The ST-1000 has been engineered to allow for maximum protection in your investments according to the European Standard EN 1522. This bullet-proof shutter offers bullet-proof FB4-S certified protection. Custom built with anodized, matte silver finish, this shutter can protect you against thieves by offering a certified Class 5 (RC 5) rating according to EN 1627 burglarproof European standard.

## ST-1000 / 2 MAXIMUM BULLET-PROOF AND BURGLAR-PROOF PROTECTION

The ST-1000/2 has been engineered to allow for maximum protection in your investments according to the European Standard EN 1522. This bullet-proof shutter offers bullet-proof FB4-S certified protection. The ST-1000/2 has been engineered to protect you against thieves offering a certified CLASS 6 (RC 6) according to EN 1627 burglar-proof European Standard. The best protection for blocking all accesses to your building and ideal for the creation of bunkers/panic rooms. Can be connected to other existing security systems.

## Ballistic rating list of our other bulletproof steel shutter systems

Underwriters Laboratory UL 752 Ballistic Standards			
UL Level	Weapon	Ammunition	Shots
1	 Baretta 9mm Parabellum	 9mm, 124 grain FMJ	3
2	 .Smith & Wesson .357 Magnum	 .357 Magnum, 158 grain JSP	3
3	 Colt .44 Magnum	 .44 Magnum, 240 grain SWC	3
4	 M-1 Garand 30-06, .30 Caliber	 .30 cal, 30-06, 180 grain JSP	1
5	 Heckler & Koch Model G3 7.62 X 51 NATO	 .30 cal, 7.62 NATO, 150 grain FMJ	1
6	 Baretta 9mm Parabellum	 9mm, 124 grain FMJ	5
7	 Colt M16 (AR15 Semi), 5.56 X 45 NATO	 .223 cal, 5.56 NATO, 55 grain FMJ	5
8	 Heckler & Koch Model G3 7.62 X 51 NATO	 .30 cal, 7.62 NATO, 150 grain FMJ	5
Shotgun Supplement			
SG 1-8	 Benelli 12GA Shotgun	 12GA, 2.75" 437 grain Slug  12GA, 2.75" 650 grain #00 Buck	